

**BOSCH**

Invented for life

Bosch SM Mega Power Plus

55B24R - Maintenance Free / Calcium, Calcium Technology

Applications

Passenger Vehicle

Bosch Master Data

Short Order Part Number

55B24R

Product Series

SM Mega Power Plus

Bosch 10 Digit Part Number

0986A00407

Technology

Calcium, Calcium

EAN Barcode

4047026240207

Warranty Period

Refer www.boschaftermarket.com.au

Refer www.boschaftermarket.co.nz

Technical Information

Nominal Voltage

12V

Nominal Capacity (20HR)

45AH

Reserve Capacity

76 Mins

Cold Cranking Amperes (CCA)

430 Amps

Case Size Dimension

Length

238 mm (9.37 inches)

Width

129 mm (5.07 inches)

Container Height

201 mm (7.91 inches)

Total Height (with Terminal)

225 mm (8.85 inches)

Case Size

B24

Approx Weight (Gross)

11.50 kg (25.30 lbs)

Terminal

(+-)

Container Material

Polypropylene

Lid Design

Labrynth Lid

Base Hold Down

-

Product Dimension & Design

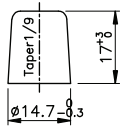

POSITIVE TERMINAL S=1:1

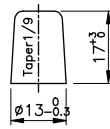

NEGATIVE TERMINAL S=1:1

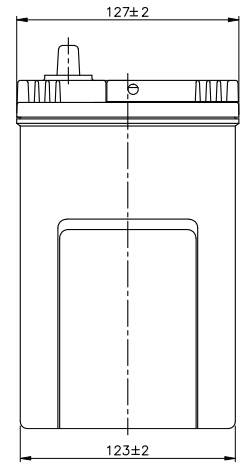
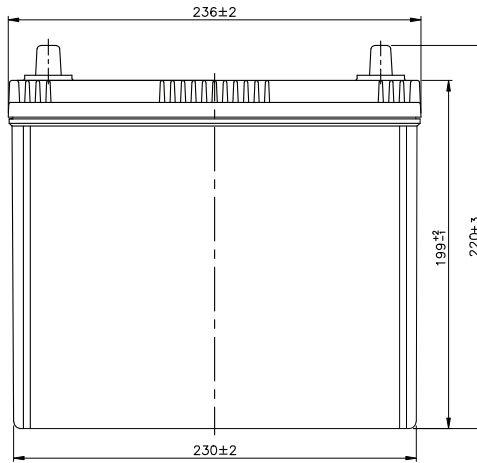
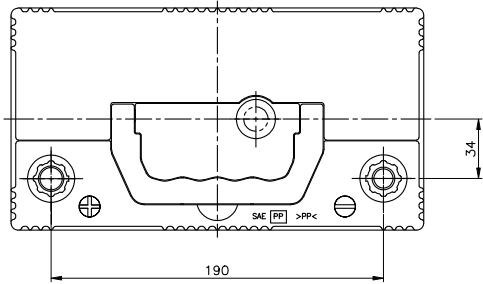

Product Performance Overview

Depth of Discharge Cycling Test

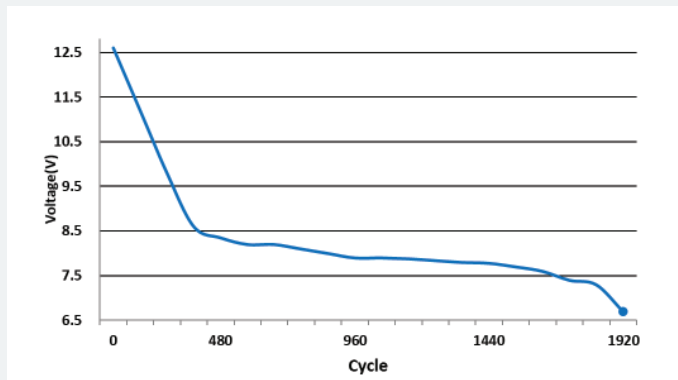

Discharge Characteristics Test

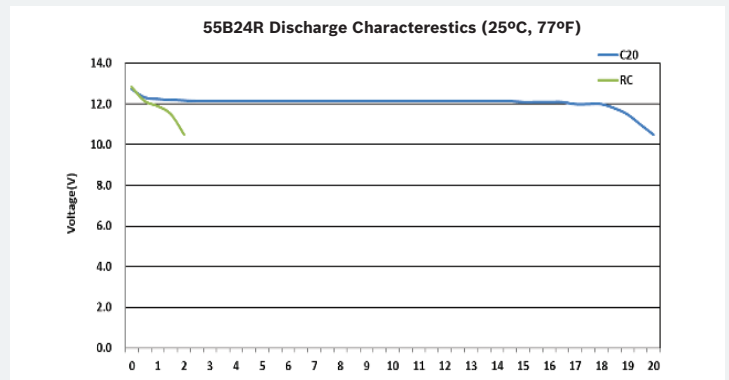

Your address for genuine Bosch quality:

Dealer stamp here: