

**BOSCH**

Invented for life

Bosch SM Mega Power Plus

55B24L - Maintenance Free / Calcium, Calcium Technology

Applications

Passenger Vehicles

Bosch Master Data

Short Order Part Number	Bosch 10 Digit Part Number	EAN Barcode
55B24L	0986A00406	4047026240214
Product Series	Technology	Warranty Period
SM Mega Power Plus	Calcium, Calcium	Refer www.boschaftermarket.com.au
		Refer www.boschaftermarket.co.nz

Technical Information

Nominal Voltage	Nominal Capacity (20HR)	Reserve Capacity
12V	45 AH	76 Mins

Cold Cranking Amperes (CCA)

430 Amps

Case Size Dimension

Length	Width	Container Height
238 mm (9.37 inches)	129 mm (5.07 inches)	201 mm (7.91 inches)

Total Height (with Terminal)

225 mm (8.85 inches)

Approx Weight (Gross)	Terminal	Container Material
11.50 kg (25.30 lbs)	(+)	Polypropylene
Lid Design	Base Hold Down	
Labrynth Lid	B	

Product Dimension & Design

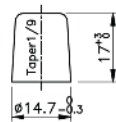

POSITIVE TERMINAL S=1:1

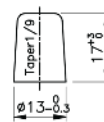

NEGATIVE TERMINAL S=1:1

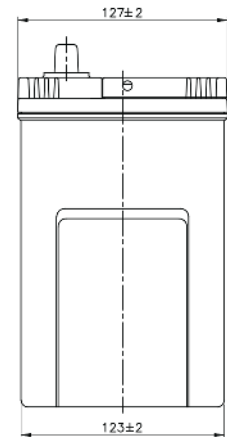
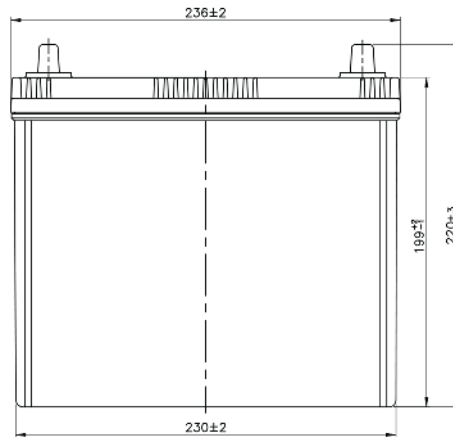
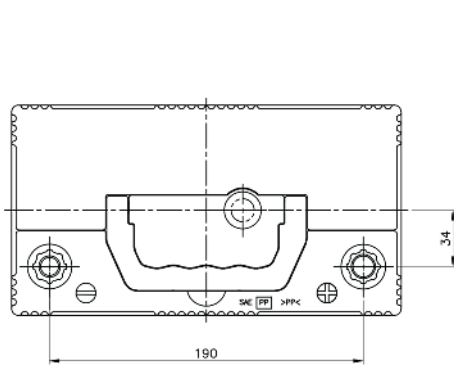

Product Performance Overview

Depth of Discharge Cycling Test

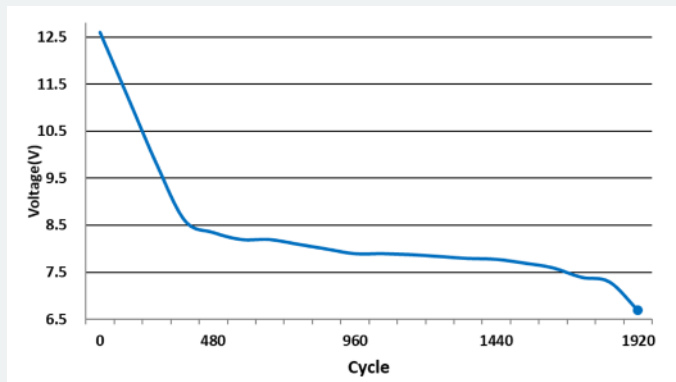

Discharge Characteristics Test

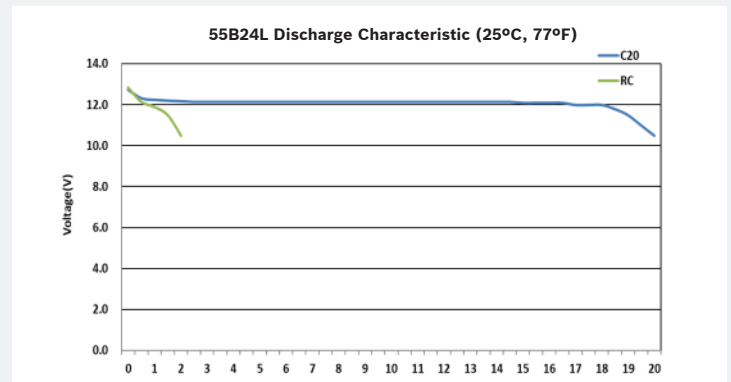

Your address for genuine Bosch quality:

Dealer stamp here: